

P-04-515

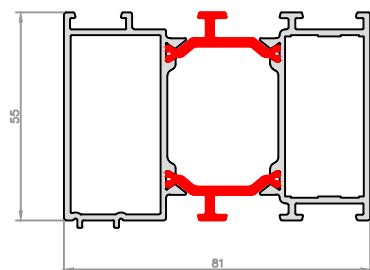

P-04-516

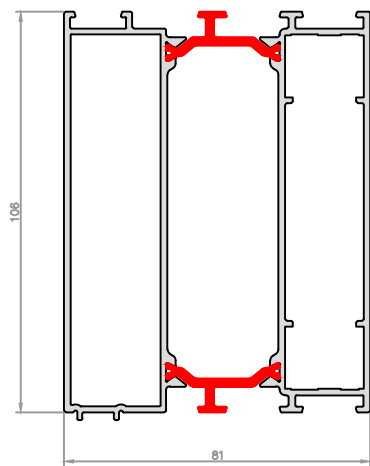

P-03-725

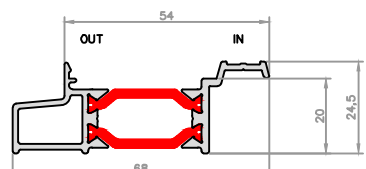

P-04-723

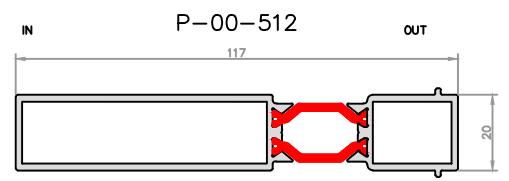
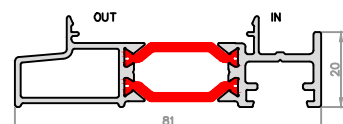

P-00-512

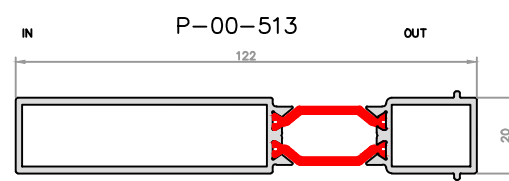

P-00-513

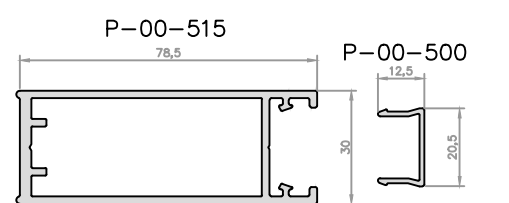

P-00-515

P-00-500

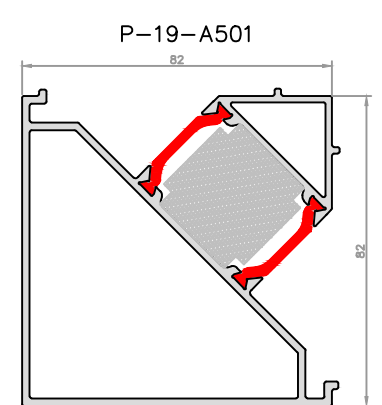

P-19-A501

P-03-726

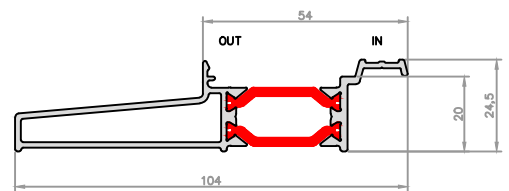

P-04-724

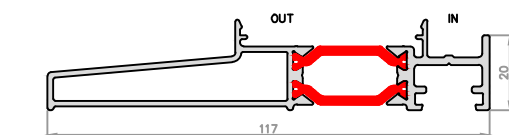

P-04-724

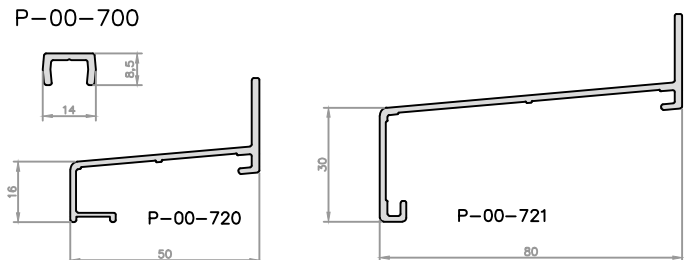

P-00-700

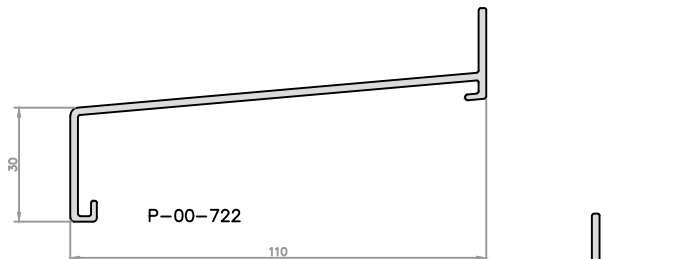

P-00-720

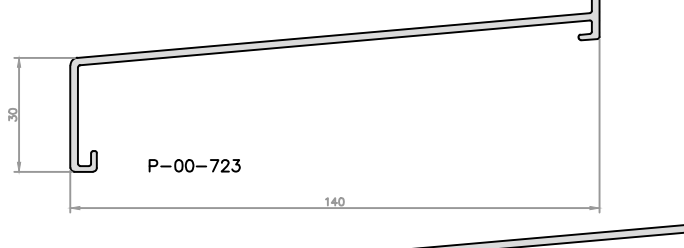

P-00-721

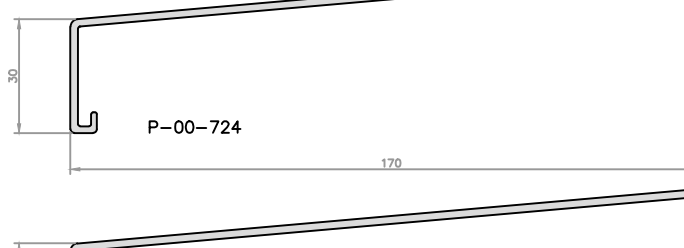

P-00-722

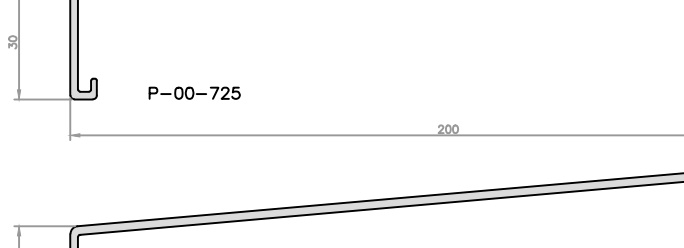

P-00-723

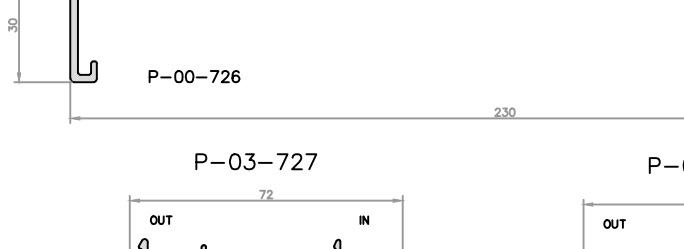

P-00-724

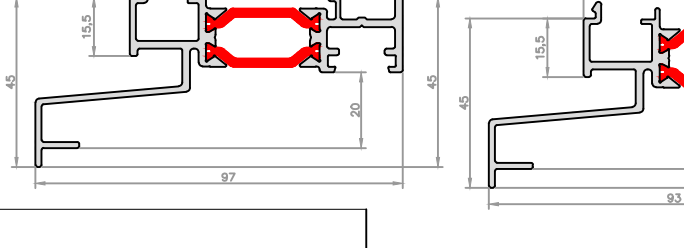

P-00-725

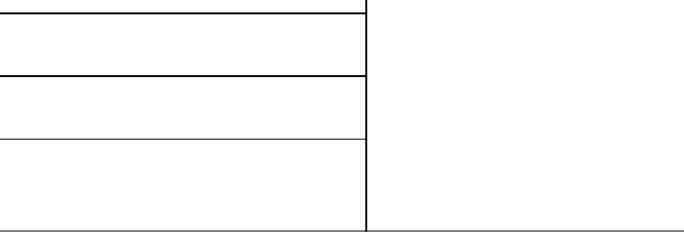

P-00-726

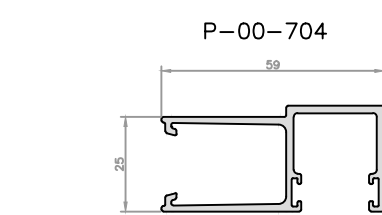

P-00-704

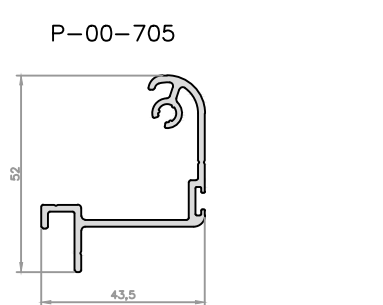

P-00-705

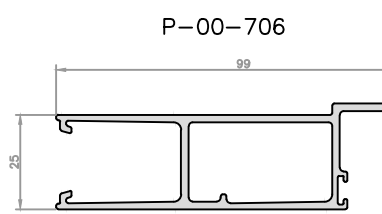

P-00-706

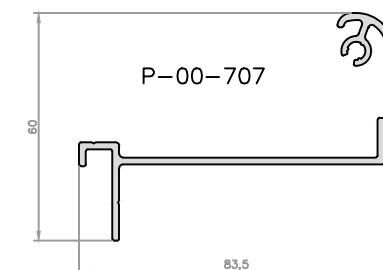

P-00-707

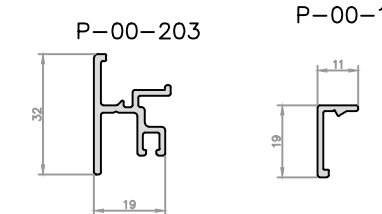

P-00-203

P-00-105

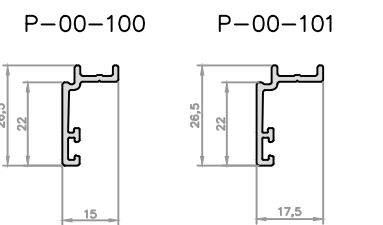

P-00-100

P-00-101

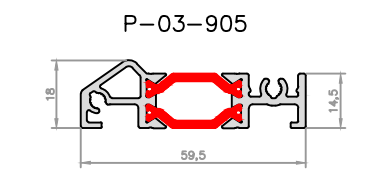

P-03-905

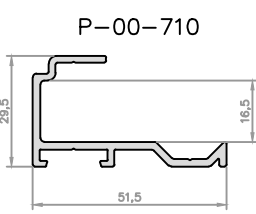

P-00-710

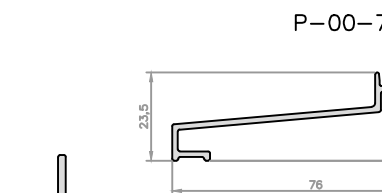

P-00-718

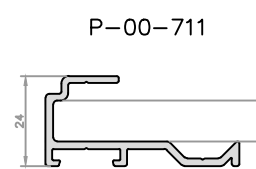

P-00-711

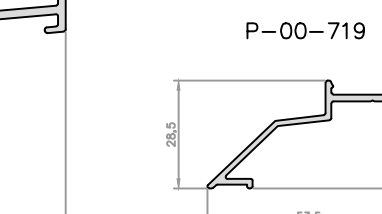

P-00-719

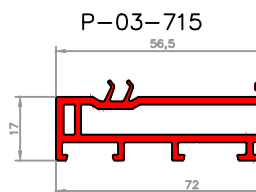

P-03-715

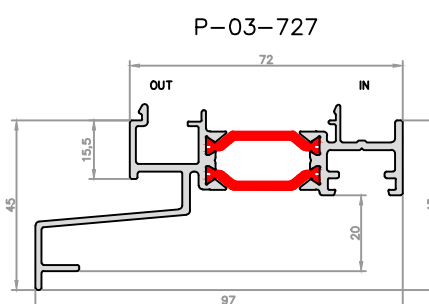

P-03-727

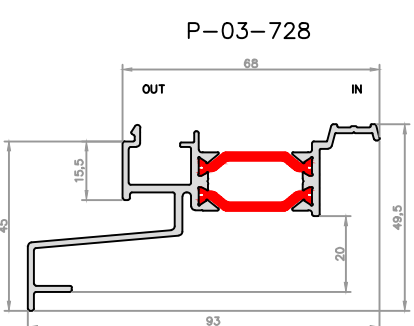

P-03-728

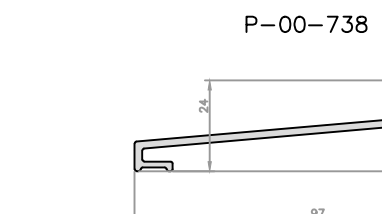

P-00-738

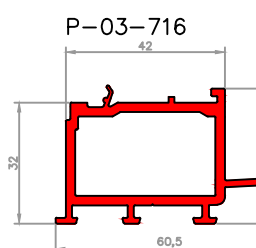

P-03-716

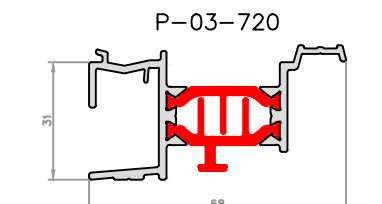

P-03-720

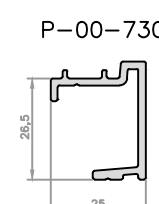

P-00-730

Vanhaverbeke Raamdesigners
 Schans 4a 2480 Dessel
 Tel. +32 (0)14 37 72 86
 www.raamdesigners.be info@raamdesigners.be
 BTW BE 0416.749.810 RPR Antwerpen, Afdeling Turnhout
 Registratienummer 416749810/022011

Datum: 19-3-2019
 Schaal: 1/2

Titel: **MINIMA | DESIGN** bijprofielen